

**EVOTECH PACIFIC**  
TECHNOLOGY SOLUTIONS

[www.evotechpacific.com.au](http://www.evotechpacific.com.au)

Fiber Laser Marking Machine  
*for Jewellery*

**L3**

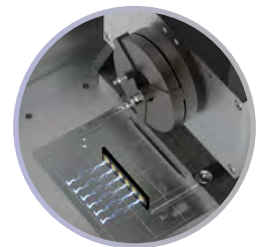
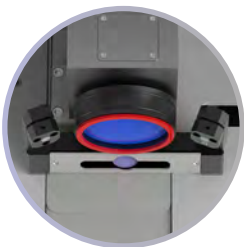



## Fiber Laser Marking Machine *for Jewellery*

### The 3rd Generation Laser Engraver for Jewellery, L3

L3 is a laser marking and cutting machine especially made for jewellery, to help jewellers utilize laser machines quickly and easily for their jewellery work. It has been developed by listening to the experiences of many jewellers and their specific demands regarding laser machines. Our main goal in the L3 development process was to offer an easy, fast, and convenient method of performing laser related jewellery work that is accessible to anyone, even novices. This goal has been achieved through our automated features, simplicity of software, powerful performance, and intuitive design for using the machine.

This 3rd-generation laser marking machine, L3, is mainly used at jewellery workshops to mark and produce jewellery products but is also very useful for performing marking services at jewellery retail stores, thanks to its compact and modern design, low noise operation and small footprint.

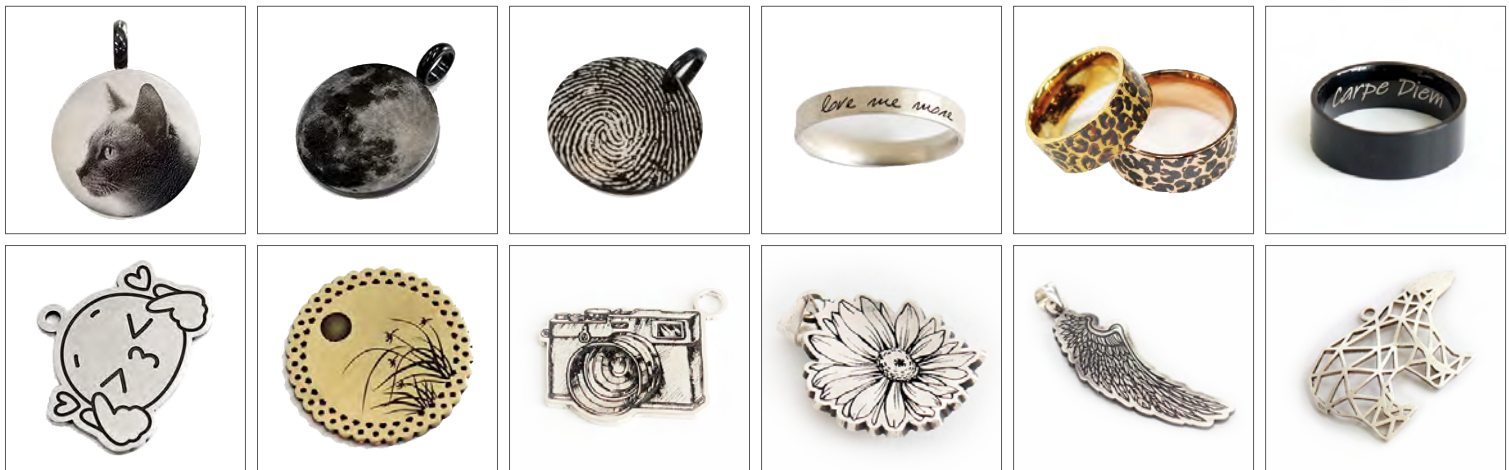
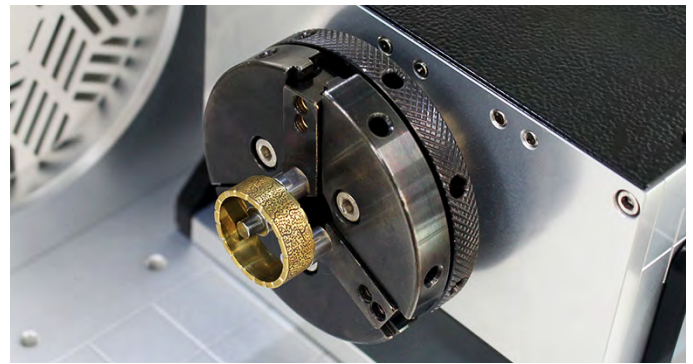

#### Uses

- Black & white marking
- Color marking Photo
- marking Cutting
- Deep engraving
- Cleaning
- 

#### Functions

- Designed for jewellery
- Black, white and Color marking
- Camera positioning and auto focusing
- 60W/100W high power cutting
- Load-N- Go docking station
- Quiet operation thanks to adaptive cooling system
- Easy and quick change between pendant and ring modes

#### Option

- Medal clamp
- Auto tilt rotary clamp
- L-type clamp
- Anti-curling clamp
- Honeycomb table
- Blower set

## Designed for Jewellery

L3 is a laser marking machine specialised for the jewellery industry, enabling jewellers to perform fine and complicated marking and cutting easily and conveniently.

- Black marking, white marking, cutting and deep marking
- Quick change between pendant and ring marking modes, thanks to the cableless docking station
- No need to remove the rotary clamp for pendant marking: this feature is built-in.
- Just slide the clamp to the left for ring marking. It is automatically recognized by the Load-N-Go system.
- The rotary clamp tilts itself automatically in accordance with the ring size. No need to set the angle manually.
- The laser focus is automatically set for interior and exterior engraving of rings. No manual focus adjustment is needed.
- A variety of optional clamps are offered for easily marking complicated jewellery products

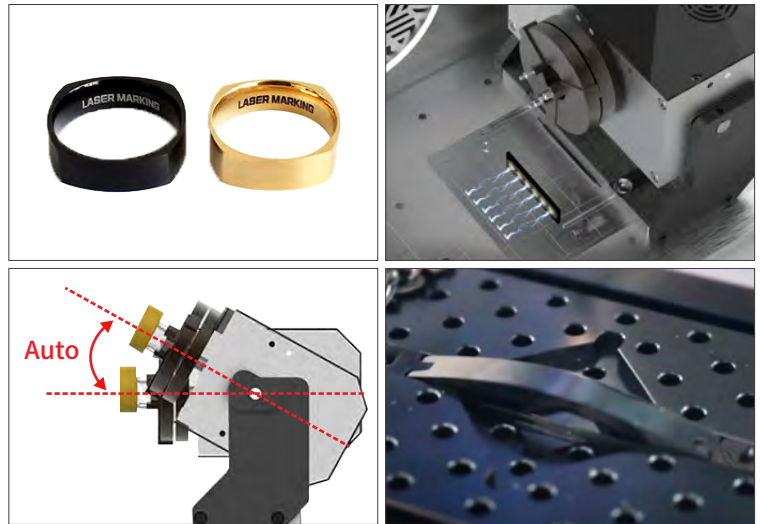

## Features for Retail Shop Use

The unique design of the L3 is optimal for jewellery retail shops as well as jewellery workrooms. Many features have been applied for in-store use. L3 is an ideal laser machine for use in a retail shop to offer customers personalisation services.

- Unique and user-friendly design fits seamlessly with the interior design of retail shops
- Small foot print requires very small space to install
- Very quiet operation, thanks to the adaptive cooling system which ensures that the fan operates only when needed with optimal speed
- Clean back panel for in-store installation. The power cord, vacuum connector, etc. can be concealed to keep the back side of the machine clear, allowing the machine fit seamlessly with the interior design of retail shops.



## Fully Automatic Laser Marking Machine

L3 comes with a variety of automated features that help anyone, even a beginner, easily use the machine without failure. Errorless, safe and fast marking or cutting is achievable thanks to many features for automatic operation.

- The camera helps design markings on the material image. This is very intuitive way of using the laser marking machine.
- Laser auto focusing automatically finds the focus point.
- The Load-N-Go docking station automatically sets the rotary clamp ready.
- The rotary clamp automatically sets its angle in accordance with the ring size.
- The electrically operating z axis is the base of automated features such as auto focusing.
- The safety door is electrically and automatically operated.
- The vacuum is electrically operated and automatically turned on and off.

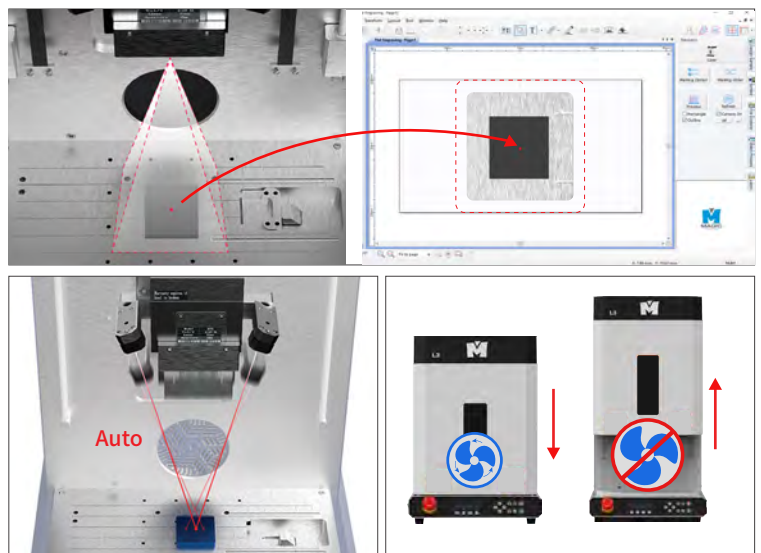

## Experience Easy Marking and Cutting

L3 offers a variety of convenient features that make jewellery marking and cutting extremely easy.

- Batch operation with various marking and cutting option mixed
- Batch engraving on materials with multilevel heights
- Engraving on curved materials
- Letter-by-letter engraving for faster performance
- Easily accessed repeat button to trigger the same operation conveniently
- Easy to use and learn with MagicArt 7 software, which is included

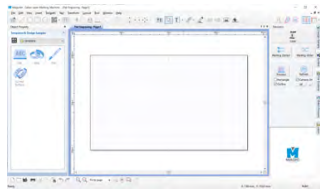

## Perfect Laser Solution for Jewellery Production (L3-60W/L3-100W)

L3-60W and L3-100W are equipped with a powerful laser source. This high performance and fine tune control of output allows users to perform jewellery marking and production easily and quickly.

- Powerful 60W or 100W output laser for faster cutting and deep engraving
- Fine-tune control of the laser output ensures high-contrast black/white marking and color marking.
- Batch process with mixture of white/blacking marking, deep engraving and cutting
- A guide to time left for completion is displayed on the screen.



## Safe Laser Marking Machine

Laser marking or cutting is a very convenient solution for jewellers, but very special care is necessary for safely using the laser. L3 comes with the following features to keep users safe from any possible risks.

- L3 complies with Class 1 standards to ensure users can operate the machine safely.
- The safety door ensures users are safe from the laser, and the dust and fume produced by the laser is prevented from scattering outside.
- The vacuum system is directly connected to the machine and automatically turned on and off.
- The vacuum intakes the dust and fumes more efficiently thanks to its internal air flowing structure.
- The sight protection glass on the safety door protects users when looking inside the door, even when without a safety goggle.
- Safety sensors detect the status of the laser machine and protect users from unsafe situations.



## Optional Clamps

Many types of optional clamps are available to be used with L3. They can be chosen in accordance with specific conditions such as material shape and type of laser work. By using the clamps properly, users can perform laser marking or cutting conveniently and quickly without errors, which is especially optimal for complicated and diverse jewellery related work.



### Auto Tilt Rotary Clamp

Used for holding ring materials in place.



### Pendant Clamps

Used for holding materials of a variety of shapes in place.

- Pendant Clamp



- Pendant Clamp (Self Centering)



### L-Type Clamp

Used for holding a material with slanted surface in place or marking a ring manually.



### Cutting Clamps

Used for holding a thin plate in place for the cutting process.

- Honeycomb Table

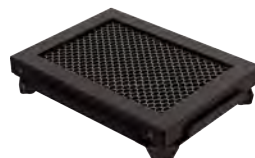

- Anticurling Clamp



## Dimension

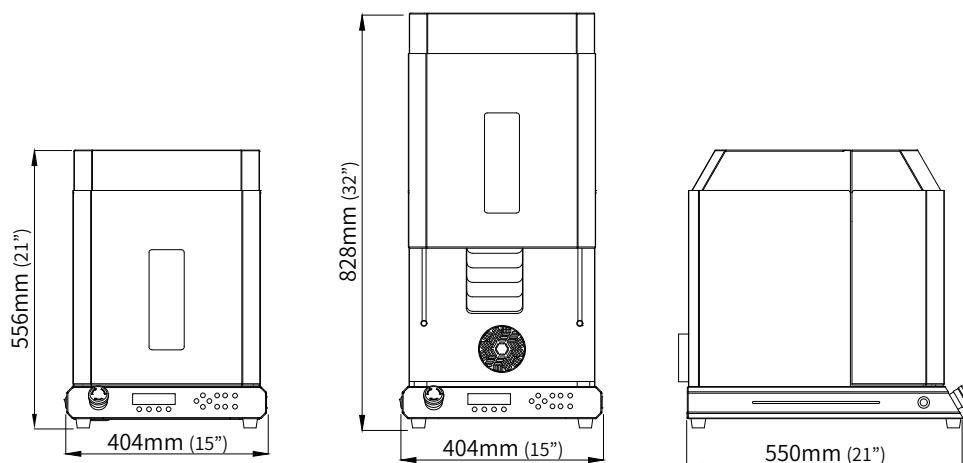

## Specification

Product				
Model	L3-20W	L3-30W	L3-60W	L3-100W
Class	Class 1 Laser Product			
Focus Laser Class	Class 2 Laser Product, <1mW			
Dimension	404mm(W) x 556mm(H) x 590mm(D)			
Marking Area	112mm x 112mm			
Max Material Height	100mm			
Max Z Stroke	100mm			
Chamber Size	350mm(W) x 100mm(H) x 170mm(D)			
Safety Door Open Height	266mm (From base plate)			
Max Material Weight	20kg			
Weight	44kg	46kg	50kg	54kg
Power	100V~240V, 50Hz/60Hz			
Power Consumption	290W	340W	520W	730W
Cooling	Air Cooling			
Temperature	0~40°			
Humidity	10~85%			
Laser				
Laser Source Type	Pulsed Wave Ytterbium Doped Fiber Laser			
Model	L3-20W	L3-30W	L3-60W	L3-100W
Average Output Power	20W	30W	60W	100W
M <sup>2</sup>	<1.5		<1.8	
Maximum Pulse Energy	0.8mJ		1.5mJ	
Pulse Repetition Rate Range	25~600KHz	37~600KHz	1~4000KHz	
Pulse Width	200ns	200ns	2~500ns	
Speed Range	4000mm/s			
Wave Length	1064nm			
Output Beam Diameter	7.0±0.5mm			
Out power Tuning Range	0~100%			
Cooling Method	Air-cooled			
Polarization	Random			
Anti-Reflection Protection	Yes			
Built-in Guide Laser	Yes			
Class (Main Source)	Class 4 Laser Product			
Class (Guide Laser)	Class 2 Laser Product, <1mW			

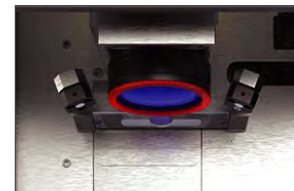

Evotech Pacific Pty Ltd

PO Box 193

Petrie QLD Australia 4502

TEL +61 7 3889 1666

Email  
anthony@evotechpacific.com.au

-Technical Support  
support@iredt.com



Made in KOREA